

1

2

3

4

A

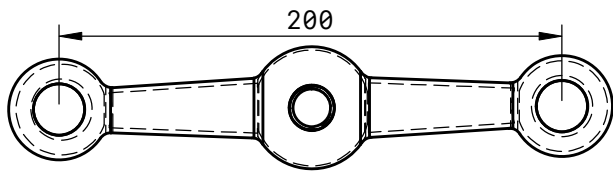

Double Arm P2002

B

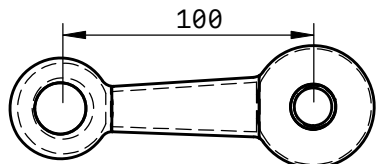

Single Arm P2001

C

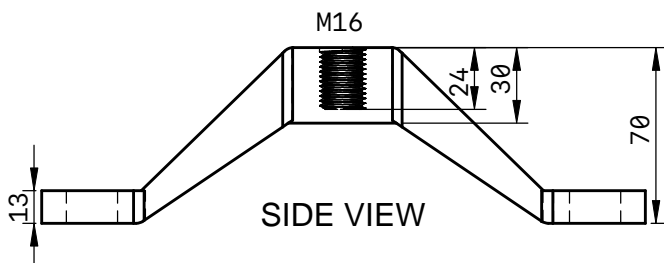

SIDE VIEW

A

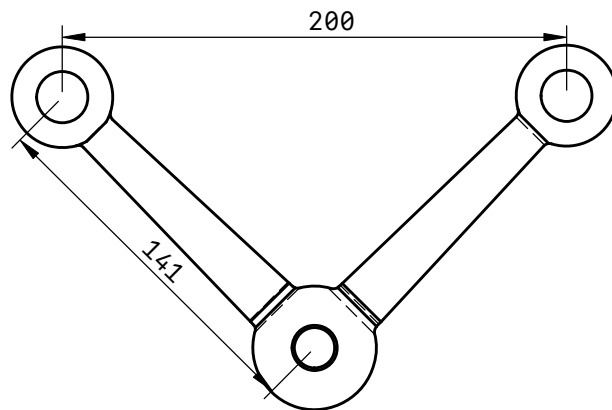

Double Arm V P2002V

B

C

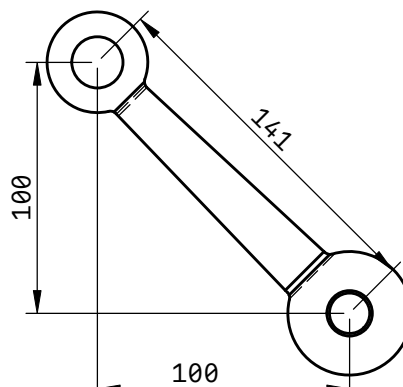

Single Long Arm P2001L

D

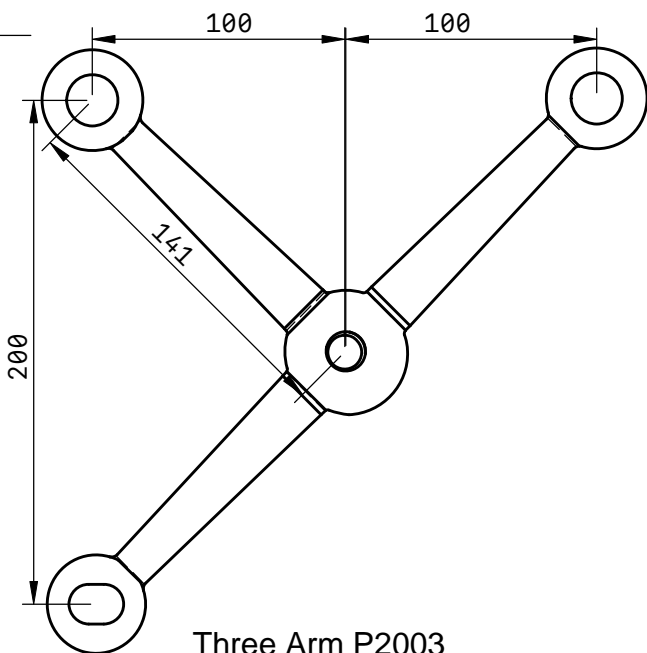

Three Arm P2003

D

E

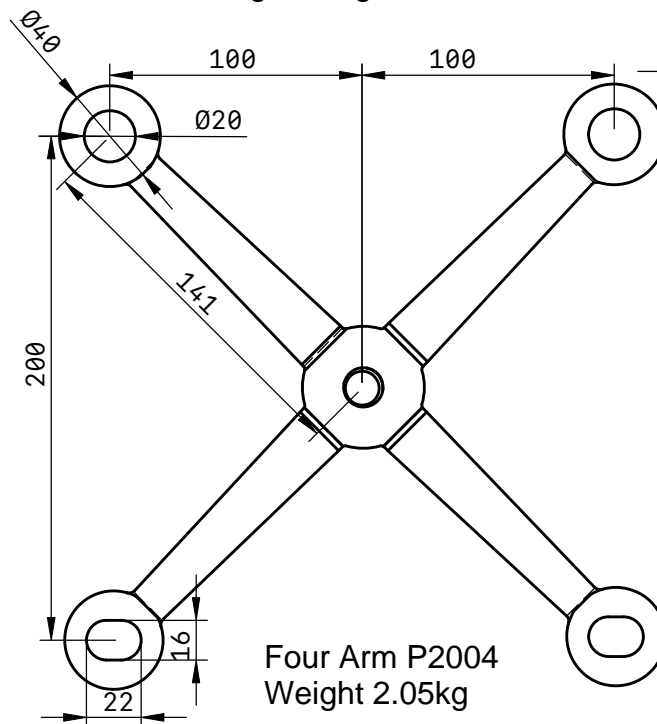

Four Arm P2004
Weight 2.05kg

E

Company: _____

Name: _____

Phone: _____

E-mail: _____

MODEL

Qwares 200mm heavy-duty spider fittings

VIEW MORE

Qwares.com/spider

UNITS

mm

MATERIAL

SS316 ()

SS304 ()

FIRST ANGLE PROJECTION



PROJECT

SURFACE

Brush ()

Polish ()

1

2

3

4

F

F